

Soft furnishings,
fitted hard
and fast.



• TC-F6H
+ TC-M6



Panel mounting solution:
TC-F6H - soft textile
TC-M6 - deck

TEXTILE TC RANGE



The Textile Range is designed for mounting soft textiles to fabrics and hard surfaces in both interior and exterior settings with clip sets holding up to a 70.5lb break out load. Utilizing a simple slide lock system, the Textile Range offers hidden and secure cushion fastening. Typical applications include sun loungers, exterior cushions on superyachts, seat bases and backs. Patent Pending.



TC-F6H TEXTILE CLIP FEMALE HEAVY DUTY

Heavy-duty female clip with quick aligning, secure slide-lock function. Stitches onto upholstery during construction process. 57.3lb pull out load with TC-M6, 70.5lb pull out load with TC-SM6. No removal tool required. For use with male clips TC-M6, TC-SM6 and TC-SM6S.

See pages 115-114 for more technical details.



TC-M6 TEXTILE CLIP MALE - SCREW FIX

White screw fix male for use with #6 screw. UV resistant. Compatible with TC-F6H.

See pages 117, 124 for more technical details.



TC-SM6S TEXTILE CLIP MALE - SEW ON

Translucent sew on male clip to be used with TC-F6H for fabric-to-fabric upholstery fixing. UV resistant.

See pages 118-125 for more technical details.



TC-SM6 TEXTILE CLIP SELF ADHESIVE MALE CLIP

Self adhesive, white surface mount male with Very High Bond (VHB) tape pre-attached for quick, durable install. Compatible with TC-F6H.

See pages 119-126 for more technical details.



TC-CF3 CARPET CLIP FEMALE

Wind in female clip for securing carpet to hard surfaces. UV resistant.

Available in white, black, gray and clear. Compatible with TC-CM6 and TC-CSM6.

See pages 112, 114-115, 119, 120 for more technical details.

! NEW



TC-CM6 CARPET CLIP MALE

White screw fix male for use with #6 screw. UV resistant.

Compatible with TC-CF3.

See pages 120, 127-128, for more technical details.

! NEW



TC-CSM6 CARPET CLIP MALE – ADHESIVE MOUNT

Self adhesive, white surface mount male with UHB tape pre-attached. UV resistant. Compatible with TC-CF3.

See pages 123, 120, 128 for more technical details.

! NEW

TOOLS

CT-10



TC-CP6H



TEXTILE TC RANGE

TC-F6H PRODUCT GUIDE

TC-F6H Textile Clip Female - Heavy Duty

Designed for textiles and soft furnishings, the TC-F6H sews onto upholstery for a heavy-duty fixing to interior and exterior surfaces.

The transparent slide-lock mechanism ensures the strongest hold to the male clip and easy cushion removal without force. Slider can be replaced in-situ without removing saddle in the event of damage.

TC-F6H



USE WITH

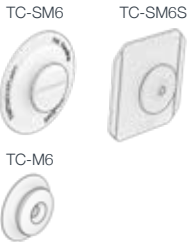

MATERIAL:

White/clear UV stabilized nylon

MORE INFO:

Installation Guide TC-M6, TC-SM6, TC-SM6S
Panel Offset Guide

INSTALLATION:

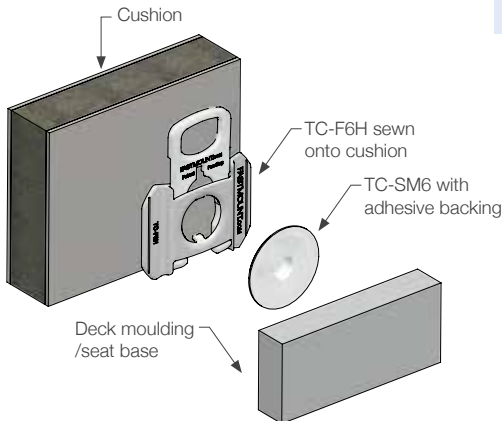

BENEFITS

- TC-F6H sews onto cushion at upholstery construction stage
- Enables heavy-duty attachment of soft furnishings to painted or gel coat surfaces
- Enables secure attachment of cushions to fabric when used with TC-SM6S
- Slide lock mechanism makes soft furnishings quick to install and easy to remove
- High quality, secure finish
- Heavy duty break out load of 57.3lb with TC-M6 & TC-SM6S or 70.5lb with TC-SM6
- No force required to release lock. Pull tab towards edge of the cushion to unlock and remove
- Hidden fixing – no visible domes, screws, straps or hook and loop tape. Low visibility transparent lock tab when exposed
- Sliding lock can be replaced without unstitching saddle in the event of damage
- No removal tool required

APPLICATIONS

- Exterior cushions
- Internal seating areas
- Sundeck mattresses and sunbeds
- Foredeck mounted mattresses
- Sun loungers

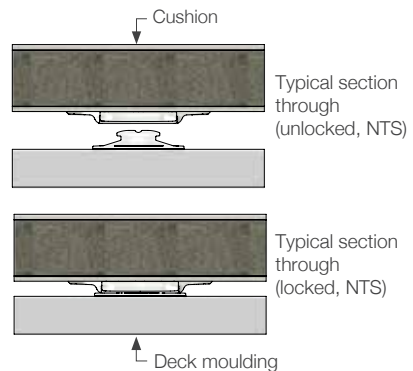

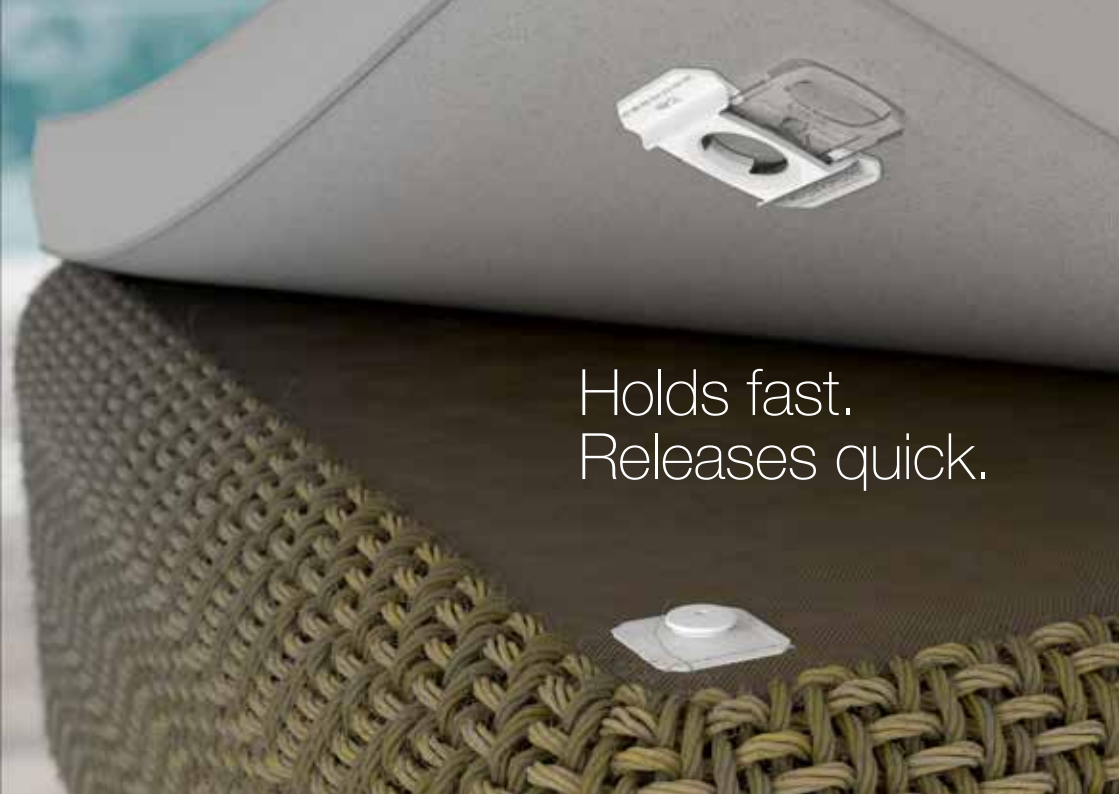

Holds fast.
Releases quick.

The TC-F6H for upholstery.

Custom-built furniture should be installed with purpose-built fixings. The Textile Range was designed specifically for fixing cushions and upholstery quickly and securely. Featuring an intuitive slide-lock mechanism, the TC-F6H female physically locks cushions into position when combined with the TC-M6, TC-SM6 or TC-SM6S. Slide to release, slide to replace, with no extra effort.



Panel mounting solution:

TC-F6H - cushion

TC-SM6S - fabric

TEXTILE TC RANGE

TC-M6 PRODUCT GUIDE

TC-M6 Male Clip

The TC-M6 fixes to a seat base, deck or other substrate with a #6 screw for a mechanical fixing to hard surfaces. The head of the clip engages with the TC-F6H for a 57.3lb break load. Ideal for both fastening both interior and exterior upholstery.

TC-M6



USE WITH

TC-F6H



MATERIAL:

White UV stabilized nylon

MORE INFO:

Installation Guide TC-M6
Panel Offset Guide

BENEFITS

- Screw fixes to deck or substrate
- Enables the attachment of soft furnishings to hard surfaces
- Makes furnishings quick to install, and easy to remove
- High quality, secure finish
- Easy alignment to replace the cushion, clip locks into place
- Purpose built
- Saves removal time for staff and crew
- Invisible fixing – no visible domes, screws, straps or hook and loop
- Break load of 57.3lb when used with TC-F6H

APPLICATIONS

- Exterior cushions
- Sundeck mattresses
- Foredeck mounted mattresses
- Seating areas external & internal
- Crew and guest areas

INSTALLATION: Partially exploded through section showing typical installation method

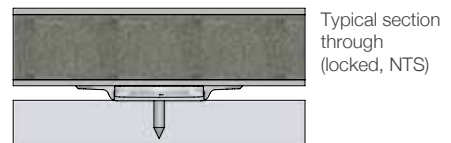
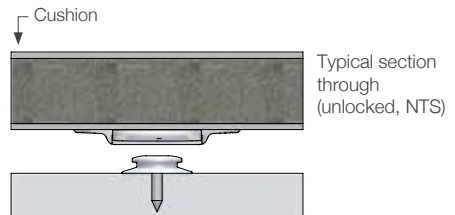
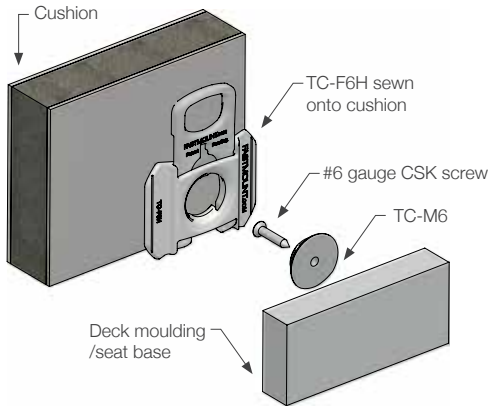

TEXTILE TC RANGE

TC-SM6S PRODUCT GUIDE

TC-SM6S Sew on male clip

The TC-SM6S is designed to be used with the TC-F6H for fabric-to-fabric upholstery fixing. The TC-SM6S is sewed to the fabric at the upholstery stage, and locks into the TC-F6H for secure fixing of upholstery and cushions. A hidden fixing ideal for sunbeds, interior and exterior furniture.

TC-SM6S



MATERIAL:

Translucent UV stabilized nylon

USE WITH

TC-F6H



MORE INFO:

Installation Guide TC-SM6S
Panel Offset Guide

BENEFITS

- Sew on during upholstery stage
- Fabric to fabric fixing
- Enables rapid removal and replacement of cushions
- Invisible fixing
- Simple installation with no special tools
- Foolproof alignment
- No force required to remove

APPLICATIONS

- Exterior cushions
- Sundeck mattresses
- Seating areas external & internal
- Crew and guest areas
- Sunbeds
- Hotels

INSTALLATION: Partially exploded through section showing typical installation method

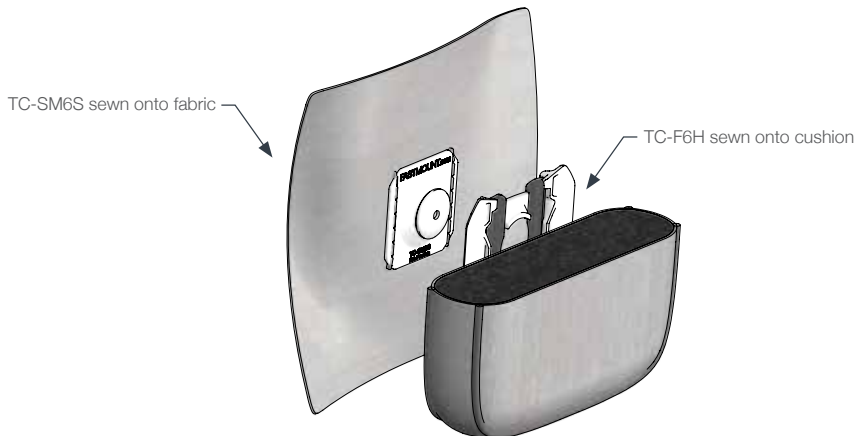

TEXTILE TC RANGE

TC-SM6 PRODUCT GUIDE

TC-SM6 Textile Clip Male - VHB Adhesive

The TC-SM6 is a white surface mount male clip with self-adhesive VHB backing for rapid and durable installation of soft furnishings. Clip attaches to hard surface and compatible with TC-F6H from the Textile Range.

TC-SM6



USE WITH

TC-F6H



MATERIAL:
White UV stabilized polycarbonate

MORE INFO:
Installation Guide TC-SM6,
Panel Offset Guide

BENEFITS

- VHB self-adhesive fix
- Enables attachment of soft furnishings to painted or gelcoat surfaces
- Makes furnishings quick to install, and easy to remove
- High quality, secure finish
- Easy alignment to replace the cushion, clip locks into place
- Purpose built
- Saves removal time for staff and crew
- Invisible fixing – no visible domes, screws, straps or hook and loop
- Break load of 70.5lb when used with TC-F6H
- Change to VHB tape is UV stabilized, bonds extremely well to painted, smooth flat surfaces.
- No penetrations or screw holes in deck structure when using TC-SM6

APPLICATIONS

- Exterior cushions
- Sundeck mattresses
- Foredeck mounted mattresses
- Seating areas external & internal
- Crew and guest areas

INSTALLATION: Partially exploded through section showing typical installation method

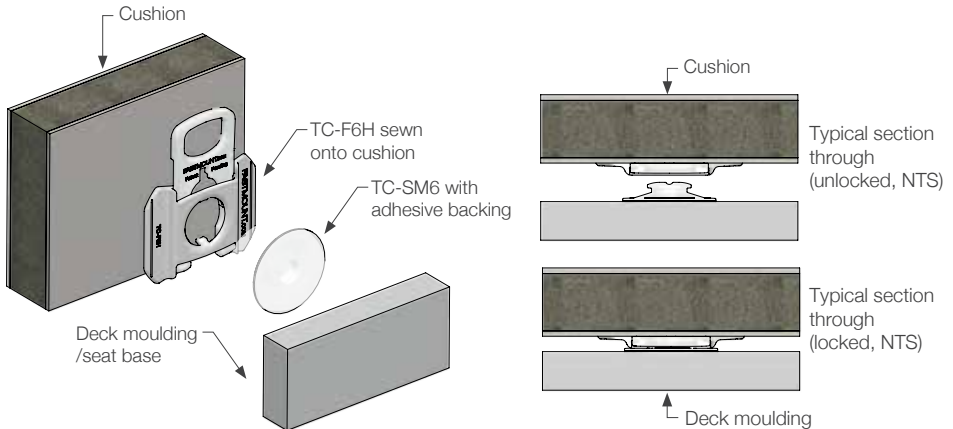

TEXTILE TC RANGE

TC-CF3 PRODUCT GUIDE

TC-CF3 Carpet Clip Female

The TC-CF3 is designed as a carpet clip for 0.12"-0.2" carpet that doesn't absorb heat from the sun, making it a superior alternative to metal studs that burn sailors' feet in marine applications. The TC-CF3 winds through a 5/8" hole punched into the carpet using the Fastmount CT-10 installation tool. The four wings tighten up onto the underside of the carpet holding it secure. Use with the TC-CSM6 on fiberglass or aluminum decks, or the stick-on TC-CSM6 can be used on a painted or fiberglass deck surface. The carpet is then clipped into place holding it secure. Use the CT-05 to lift the carpet off the male clip. 1' 3 3/4" max spacing recommended between clips. Available in white, black, gray and clear.

TC-CF3



! NEW

MATERIAL: Polycarbonate
MORE INFO: Installation Guide TC-CM6, TC-CSM6

USE WITH

TC-CM6



TC-CSM6



BENEFITS

- Quick and easy to install
- Cost-effective as minimal parts are required for fitting
- Protects skin from heat or burns where there is harsh exposure to sun
- Secures loose carpets to avoid trips or falls
- High quality, secure finish
- Designed as an improvement on traditional fixed methods
- Easy removal for cleaning, winterizing or replacement

APPLICATIONS

- Suitable for marine, architectural, aviation and RV
- Designed for 0.12"-0.2" carpet
- Interior and exterior fitted carpets
- Mats and loose fitting rugs
- Covers for machinery or outdoor furniture
- Refits and upgrades of existing installations

INSTALLATION:

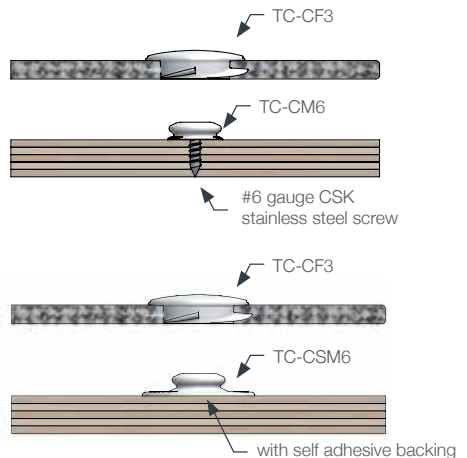
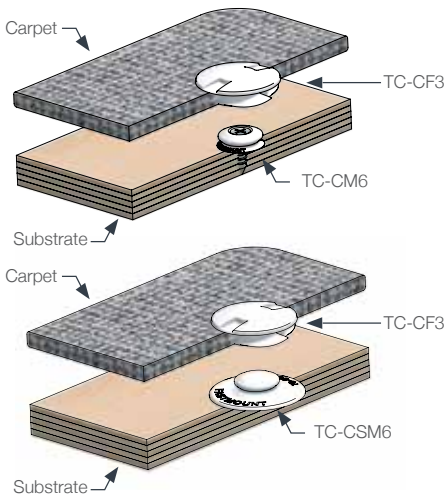

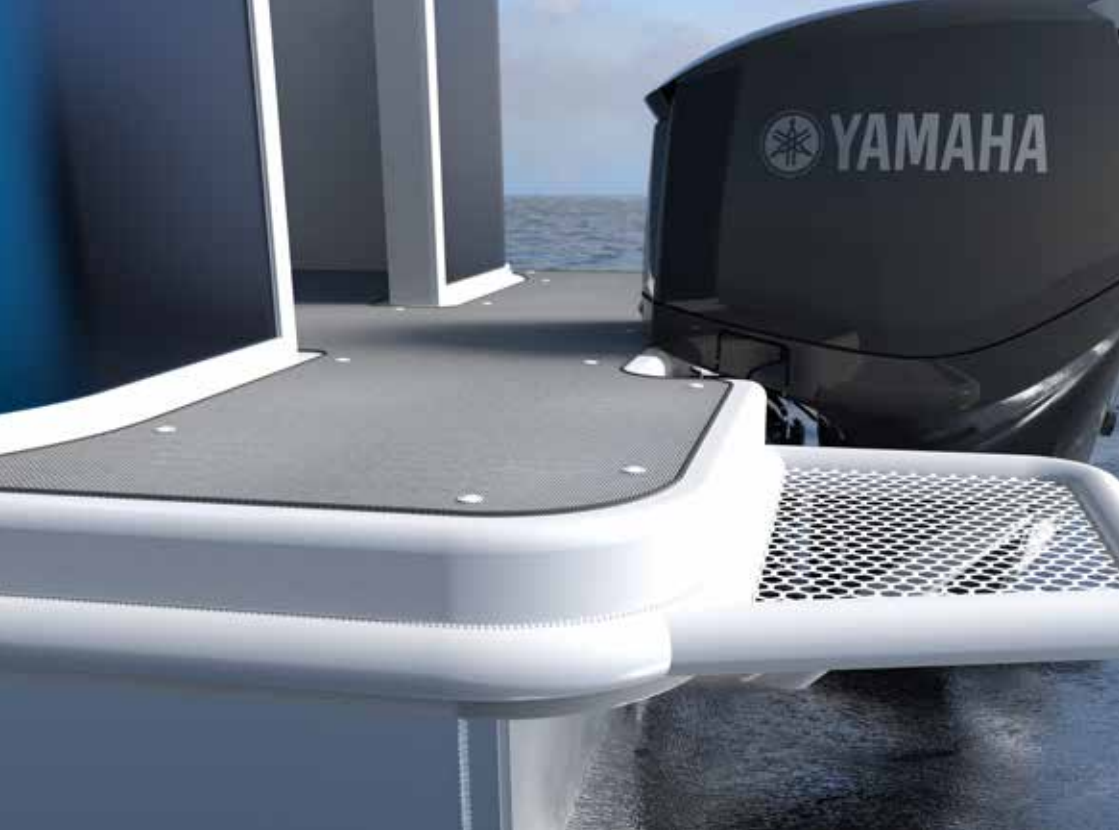

Carpets in place and passengers safe.

The new carpet clip for boat decks from Fastmount is a superior alternative to metal. Crafted from heat-resistant polycarbonate, it remains cool under the sun. Its innovative design allows easy lifting of the carpet for cleaning or replacement, providing convenience and safety for boat owners.

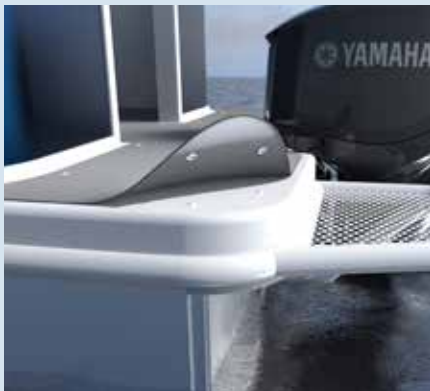

Panel mounting solution:

TC-CF3 - carpet

TC-CM6 - substrate

Functional flexibility—effortlessly lift the carpet for cleaning or replacement using the CT-05 tool.

TEXTILE TC RANGE

TC-CM6 PRODUCT GUIDE

TC-CM6 Carpet Clip Male

The TC-CM6 is designed to screw fix onto hard surfaces as part of a solution for fixing removable carpet in place. Suitable for fiberglass or aluminum decks with no special tools required. Use with the TC-CF3 female which winds through the carpet then clips into place holding it secure. Use the CT-05 to lift the carpet off the male clip. 1' 3 3/4" max spacing recommended between clips.

TC-CM6



! NEW

USE WITH

TC-CF3



MATERIAL:

Unfilled nylon

MORE INFO:

Installation Guide TC-CM6

BENEFITS

- Quick and easy to install, with no special tools required
- Cost-effective as minimal parts are required for fitting
- Protects skin from heat or burns where there is harsh exposure to sun
- Secures loose carpets to avoid trips or falls
- High quality, secure finish
- Designed as an improvement on traditional fixed methods
- Easy removal for cleaning, winterizing or replacement

APPLICATIONS

- Hard surfaces like fiberglass, painted surfaces, timber or concrete
- Interior and exterior fitted carpets
- Mats and loose fitting rugs
- Covers for machinery or outdoor furniture
- Refits and upgrades of existing installations

INSTALLATION: Partially exploded through section showing typical installation method

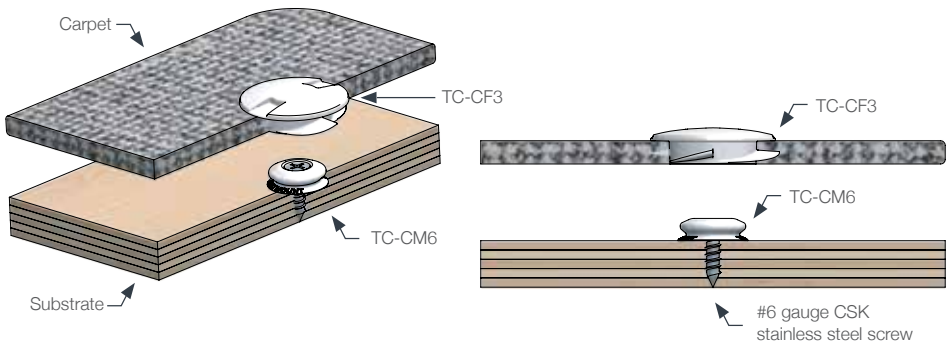

TEXTILE TC RANGE

TC-CSM6 PRODUCT GUIDE

TC-CSM6 Carpet Clip Male – Adhesive Mount

The TC-CSM6 adheres to hard surfaces using UHB tape as part of a solution for fixing removable carpet in place. Suitable for painted or fiberglass decks with no special tools required. Use with the TC-CF3 female which winds through the carpet then clips into place holding it secure. Use the CT-05 to lift the carpet off the male clip. 1' 3 3/4" max spacing recommended between clips.

TC-CSM6S



! NEW

MATERIAL:
Unfilled nylon
UHB tape

USE WITH

TC-CF3



MORE INFO:
Installation Guide TC-CSM6

BENEFITS

- Quick and easy to install, with no special tools required
- Cost-effective as minimal parts are required for fitting
- Protects skin from heat or burns where there is harsh exposure to sun
- Secures loose carpets to avoid trips or falls
- High quality, secure finish
- Designed as an improvement on traditional fixed methods
- Easy removal for cleaning, winterizing or replacement

APPLICATIONS

- Fix to fiberglass or painted surfaces
- Interior and exterior fitted carpets
- Mats and loose fitting rugs
- Covers for machinery or outdoor furniture
- Refits and upgrades of existing installations

INSTALLATION: Partially exploded through section showing typical installation method

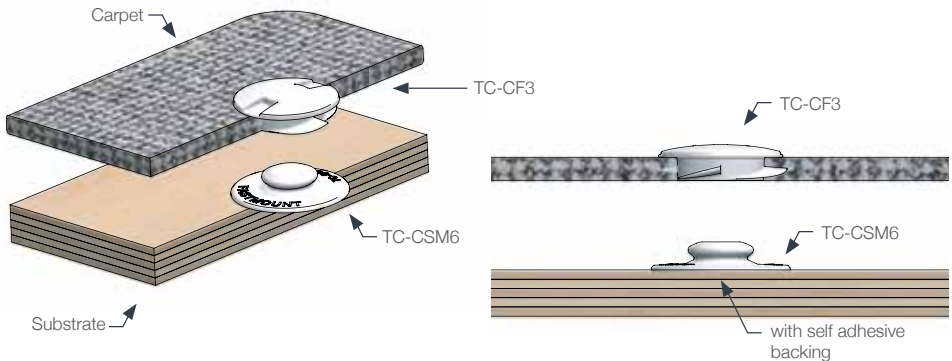

TEXTILE TC RANGE

TC-F6H & TC-SM6 INSTALLATION GUIDE

TC-F6H & TC-SM6 Textile Clip Range

TC-F6H



TC-SM6



USE WITH:

Upholstery sewing machine using standard foot, size 110/18 needle and V92 thread.

For optimum adhesion, wipe the mounting surface clean with alcohol or solvent wipe and dry before pressing TC-SM6 to surface. Wait 24 - 72 hours before installing cushions.

INSTALLATION STEPS:

- 1** Sew TC-F6H to fabric using 110/18 needle and V92 size thread along stitch groove.

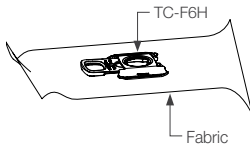

- 1B** Close up of TC-F6H sewn on

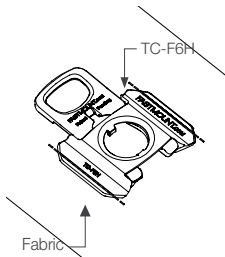

- 2** Complete cushion assembly

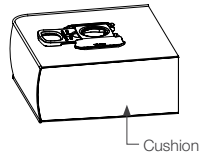

- 3** Insert TC-SM6 into TC-F6H

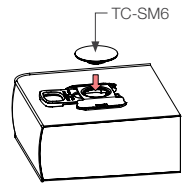

- 4** Lock TC-F6H

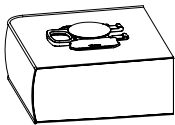

- 5** Peel off TC-SM6 backing

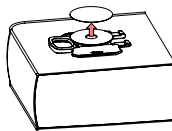

- 6** Align cushion in position

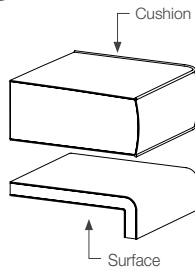

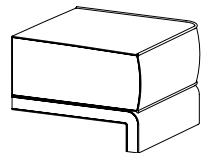

- 7** Press down firmly in place. To disengage, pull slide lock towards edge of cushion.



TEXTILE TC RANGE

TC-F6H & TC-M6 INSTALLATION GUIDE

TC-F6H & TC-M6 Textile Clip Range

TC-F6H	TC-M6	USE WITH:	INSTALL WITH:
		Upholstery sewing machine using standard foot, size 110/18 needle and V92 thread. #6 screw	

INSTALLATION STEPS

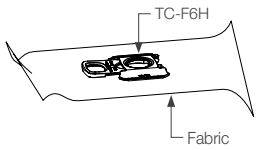
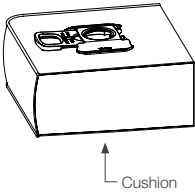
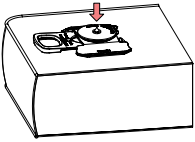
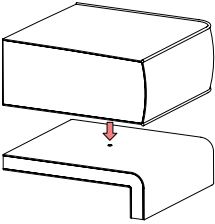
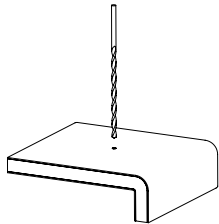
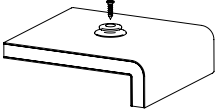
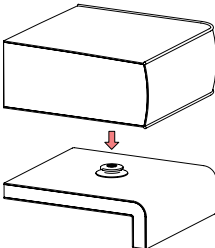
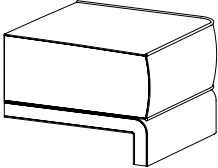
<p>1 Sew TC-F6H to fabric using 110/18 needle and V92 size thread along stitch groove.</p> 	<p>2 Complete cushion assembly.</p> 	<p>3 Insert TC-CP6H into TC-F6H. Press slider to hold TC-CP6H in place.</p> 	<p>4 Align cushion and press firmly on mounting surface.</p> 
<p>5 Drill on mark.</p> 	<p>6 Screw TC-M6 onto base using #6 gauge CSK screw.</p> 	<p>7 Align cushion with TC-M6.</p> 	<p>7 Press cushion into place. To engage, slide lock away from cushion edge, to disengage, pull lock towards edge.</p> 

TEXTILE TC RANGE

TC-F6H & TC-SM6S INSTALLATION GUIDE

TC-F6H & TC-SM6S Textile Clip Range

TC-F6H



TC-SM6S



USE WITH:

Upholstery sewing machine using standard foot, size 110/18 needle and V92 thread.

INSTALLATION STEPS

- 1 Cut fabric to shape.

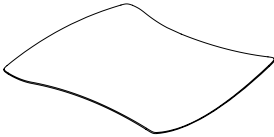

- 2 Mark location of TC-SM6S and position clip about 2.8" away from edge.

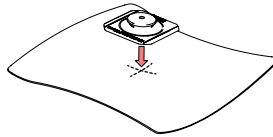

- 3 Sew TC-SM6S to fabric using 110/18 needle and V92 size thread along stitch groove.

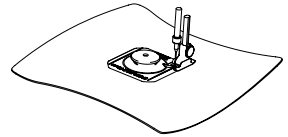

- 4 Cut cushion fabric to shape

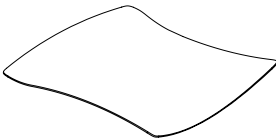

- 5 Mark location of TC-F6H and position clip about 2.8" away from cushion edge

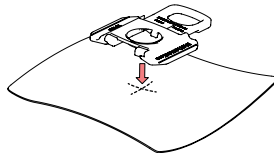

- 6 Sew TC-F6H to fabric using 110/18 needle and V92 size thread along stitch groove.

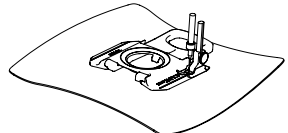

- 7 Complete construction of cushion

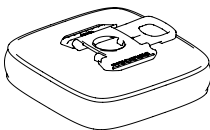

- 8 To lock cushion into place, align clips. To engage, slide lock away from cushion edge, to disengage, pull lock towards edge of cushion.

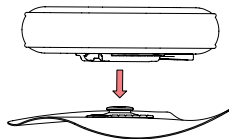

TEXTILE TC RANGE

TC-CF3 & TC-CM6 INSTALLATION GUIDE

TC-CF3 & TC-CM6 Carpet Clip Range

TC-CF3



TC-CM6



USE WITH:

#6 CSK stainless steel screw or M6 machine screws

INSTALL WITH:

CT-10

5/8"
hole punch



INSTALLATION STEPS:

- 1 Punch 5/8" hole in carpet

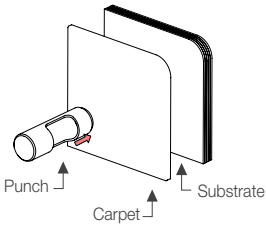

- 2 Drill 1/8" hole in substrate

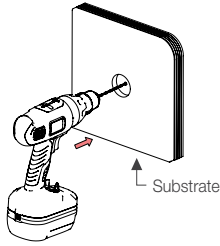

- 3 Screw fix TC-CM6 with #6 CSK stainless steel screw

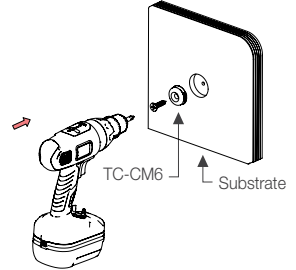

- 4 Install TC-CF3 with CT-10

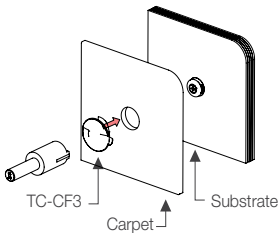

- 5 Apply carpet to substrate

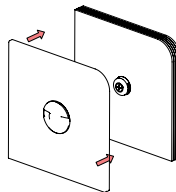

TEXTILE TC RANGE

TC-CF3 & TC-CSM6 INSTALLATION GUIDE

TC-CF3 & TC-CSM6 Carpet Clip Range

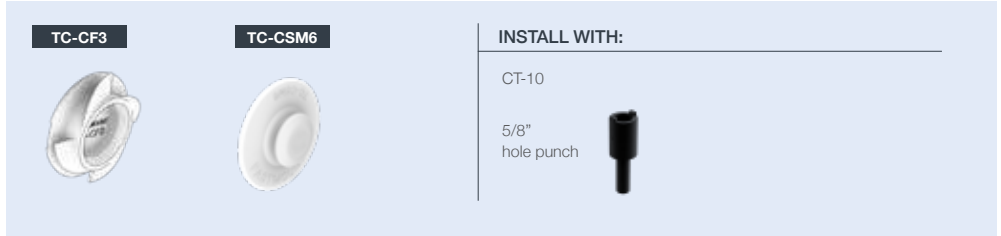

INSTALLATION STEPS:

- 1** Punch 5/8" hole in carpet

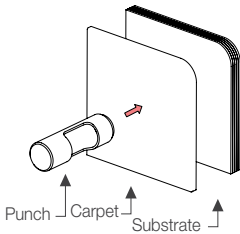

- 2** Install TC-CF3 with CT-10

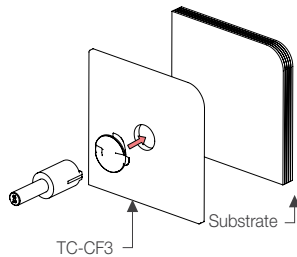

- 3** Insert TC-CSM6 into TC-CF3

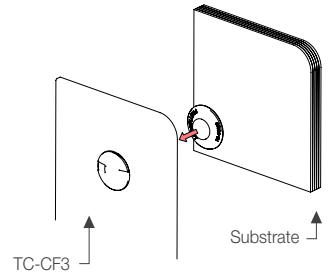

- 4** Remove adhesive backing from TC-CSM6

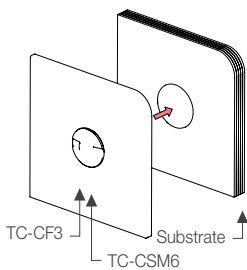

- 5** Apply carpet to substrate

