

PANELSAFE PS RANGE

PS-150 INSTALLATION GUIDE

PS-150 PanelSafe Restraint System

PS-150



USE WITH:

PC Standard Range
LP Low Profile Range
VL Very Low Profile Range
MC Metal Range

INSTALL WITH:

CP-01ST CT-01 CT-09 CT-07 CT-03 CT-10

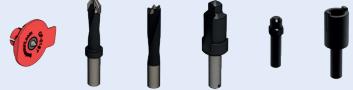

INSTALLATION STEPS Page 1

- 1 Drill hole through panel and frame

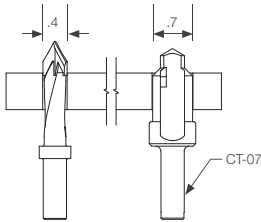

- 2 Screw PanelSafe in 0.7"Ø hole

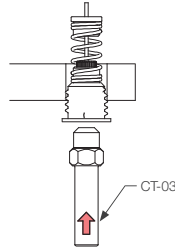

- 3 Fit CP-01ST into PanelSafe to mark panel

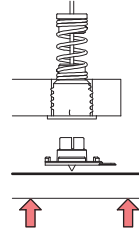

- 4 Drill panel on center mark
7.5mm deep

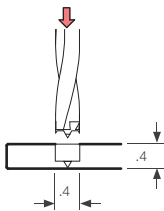

- 5 Screw fit PS-M with CT-10

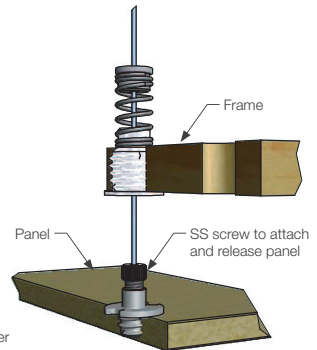
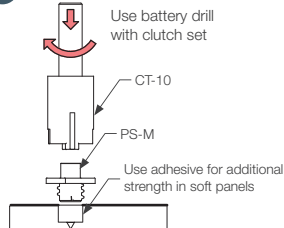

- 6 Completed installation

