

STRATLOCK SL RANGE

SL-SMT1 INSTALLATION GUIDE

SL-SMT1 Stratlock™ Sidemount

- Installation with PanelSafe Easyfit

SL-SMT1

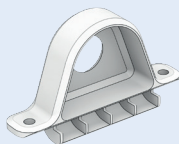

USE WITH:

PS-150E PS-S150E

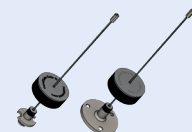

INSTALL WITH:

#8 screws

INSTALLATION STEPS Installation with PanelSafe

1 Insert SL-SMT1 into SL-RLE

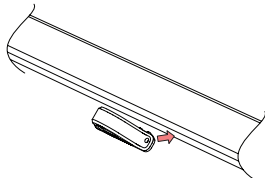

2 Click into place

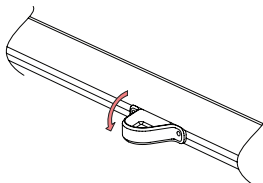

3 Use #8 screws to fix SL-SMT1 into position

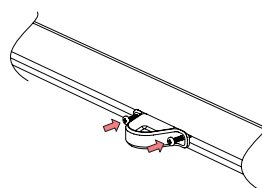

4 Pass the PS-150E or PS-S150E through SL-SMT1 and attach to panel with appropriate Stratlock Range clips already installed

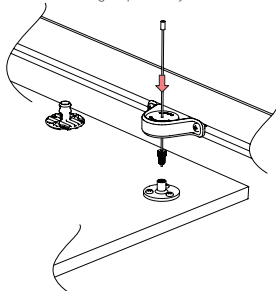

5 Clip panel into position

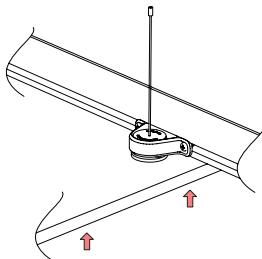

Stratlock SL-RLE shown.

STRATLOCK SL RANGE

SL-SMT1 INSTALLATION GUIDE

SL-SMT1 Stratlock™ Sidemount

- Suspension of SL-RLE with M10 threaded rod hanger



INSTALLATION STEPS using M10 threaded rod hanger

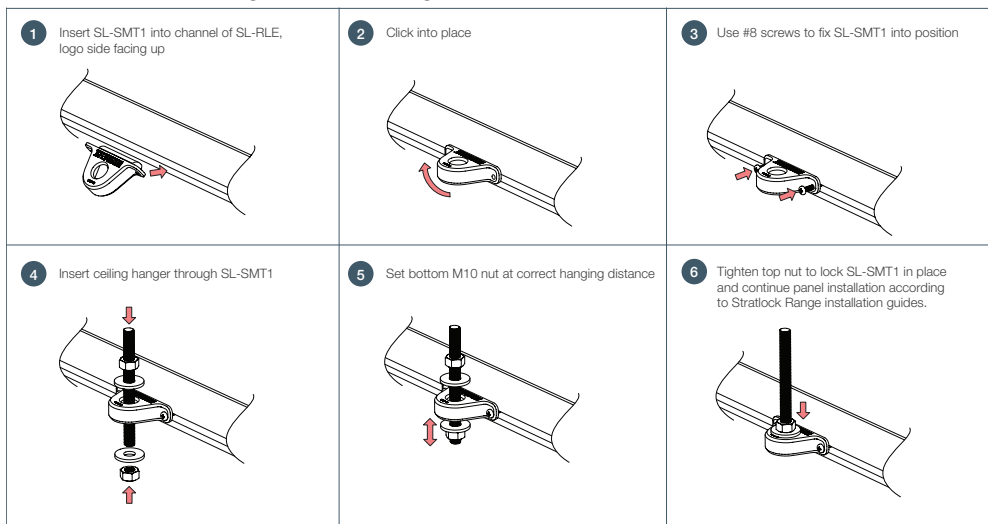

Stratlock SL-RLE shown.